

LUBRICATION POINTS

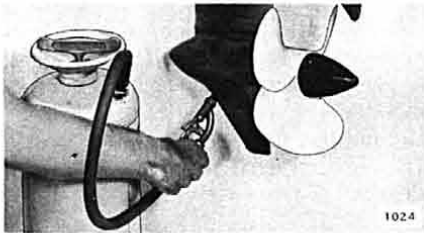

Figure 2-3. Gearcase

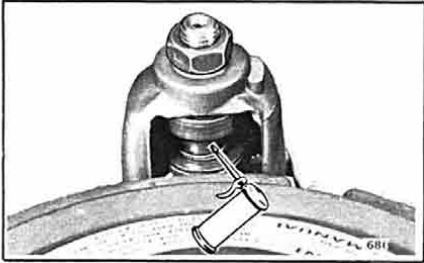

Figure 2-4. Starter Pinion Gear Shaft

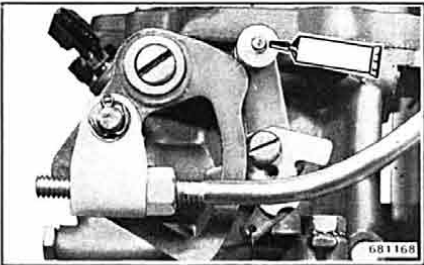

Figure 2-5. Carburetor Linkage

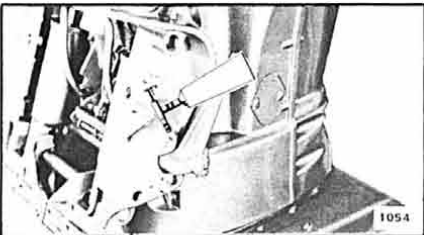

Figure 2-6. Tilt and Trailing Lever

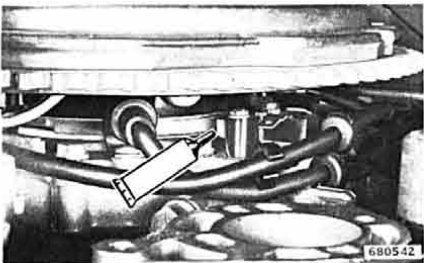

Figure 2-7. Safety Switch Cam

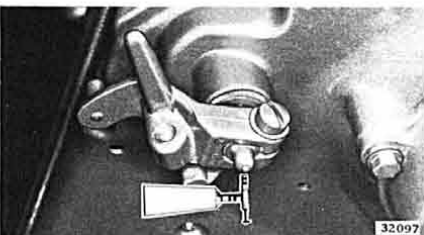

Figure 2-8. Throttle Shaft Gears

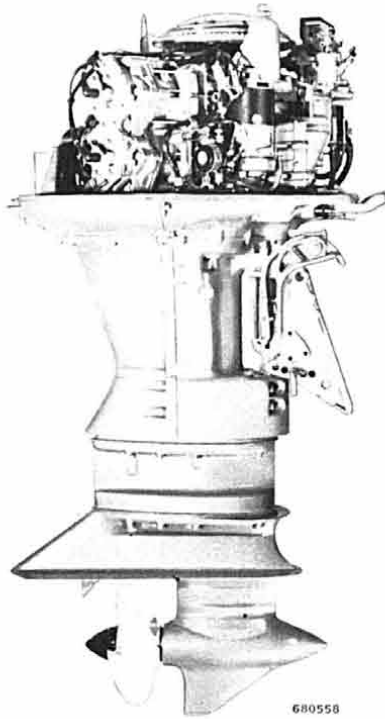

Figure 2-1. Starboard Side

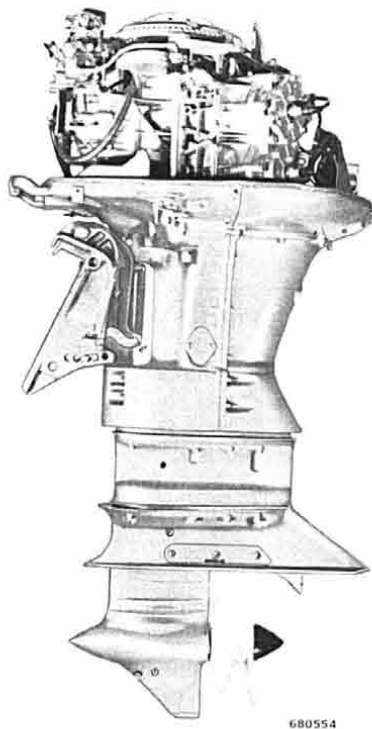

Figure 2-2. Port Side

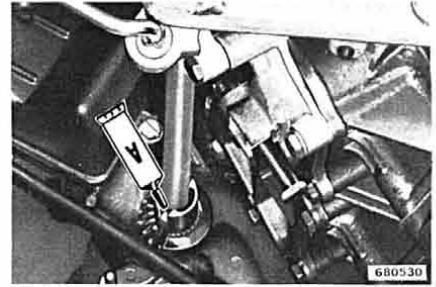

Figure 2-9. Throttle Shaft Lower Bushing

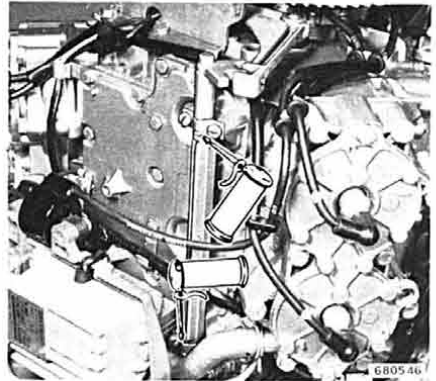

Figure 2-10. Lock Shaft Bearing Clamps

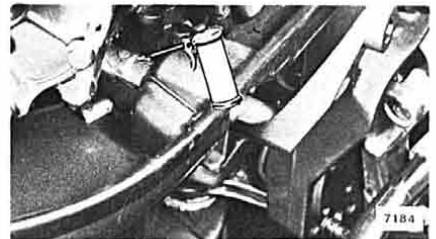

Figure 2-11. Throttle & Shift Shaft Bearings

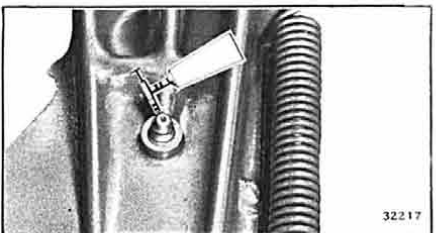

Figure 2-12. Swivel Bracket Fitting

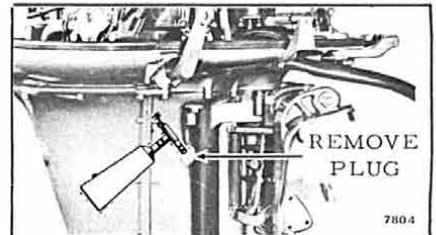

Figure 2-13. Gear Shift Linkage